



ResMed

AirCurve™ 10 VAUTO

S



Clinical guide
English

Contents

- Welcome 1
 - Indications for use 1
 - AirCurve 10 VAuto 1
 - AirCurve 10 S 1
 - Contraindications 1
 - Adverse effects 1
- At a glance 2
- About the control panel 3
- Therapy information 4
 - Bilevel pressures 4
 - VAuto mode 4
 - Min EPAP, Max IPAP and pressure support in VAuto mode 4
 - S mode 4
 - Triggering and cycling 5
 - TiControl - Inspiratory time control 5
 - Rise time adjustment 6
 - CPAP mode 6
 - Central sleep apnoea detection 6
 - Leak management with VSync 7
- Comfort features 7
 - Ramp 7
 - Expiratory Pressure Relief 7
 - Easy-Breathe 8
 - Climate Control 8
 - Climate Control Auto 8
 - Climate Control Manual 8
- Setup 10
 - Supplemental oxygen 11
 - Antibacterial filters 11
- Accessing and exiting the Clinical Menu 12
 - Adjusting the clinical settings 12
 - Setting the date and time 13
 - Settings menu 14
 - Therapy 14
 - Comfort 15
 - Accessories 16
 - Options 16
 - Configuration 16
- Starting therapy 17
- Stopping therapy 17
 - Viewing the Sleep Report 18
 - Sleep Report screen parameters 18
- Cleaning and Maintenance 20
 - Disassembling 20
 - Cleaning 20
 - Checking 21
 - Reassembling 21
- Reprocessing 22
 - Surface disinfection 22

Reprocessing the air tubing	23
Disconnecting	23
Decontaminating.....	23
Disinfecting.....	23
Inspecting	24
Reconnecting the air tubing	24
Packaging and storage	24
Reprocessing the humidifier and air outlet	25
Disassembling.....	25
Decontaminating.....	26
Disinfecting.....	26
Inspecting	27
Reassembling	27
Packaging and storage	28
Data management and therapy compliance	28
Remote monitoring	28
SD card.....	29
Data storage	29
Software upgrade.....	30
Managing patient care	30
Patient menu	30
Therapy data.....	30
Travelling	31
Travelling by plane	31
Troubleshooting.....	31
General troubleshooting.....	31
Device messages.....	33
General warnings and cautions.....	34
Technical specifications	35
Symbols.....	39
Servicing.....	39
Limited warranty	40

Welcome

The AirCurve™ 10 VAuto and AirCurve 10 S are bilevel positive airway pressure devices.

WARNING

- Read this entire guide before using the device.
- Use the device according to the intended use provided in this guide.
- The advice provided by your prescribing doctor should be followed ahead of the information provided in this guide.

Indications for use

AirCurve 10 VAuto

The AirCurve 10 VAuto device is indicated for the treatment of obstructive sleep apnoea (OSA) in patients weighing more than 30 kg or more than 13 kg in CPAP and S modes. It is intended for home and hospital use.

The humidifier is intended for single patient use in the home environment and re-use in a hospital/institutional environment.

AirCurve 10 S

The AirCurve 10 S device is indicated for the treatment of obstructive sleep apnoea (OSA) in patients weighing more than 13 kg. It is intended for home and hospital use.

The humidifier is intended for single patient use in the home environment and re-use in a hospital/institutional environment.

Contraindications

Positive airway pressure therapy may be contraindicated in some patients with the following pre-existing conditions:

- severe bullous lung disease
- pneumothorax or pneumomediastinum
- pathologically low blood pressure, particularly if associated with intravascular volume depletion
- dehydration
- cerebrospinal fluid leak, recent cranial surgery, or trauma.

Adverse effects

Patients should report unusual chest pain, severe headache, or increased breathlessness to their prescribing physician. An acute upper respiratory tract infection may require temporary discontinuation of treatment.

The following side effects may arise during the course of therapy with the device:

- drying of the nose, mouth, or throat
- nosebleed
- bloating
- ear or sinus discomfort
- eye irritation
- skin rashes.

At a glance

The AirCurve 10 includes the following:

- Device
- HumidAir™ humidifier
- Air tubing
- Power supply unit
- Travel bag
- SD card (already inserted).

A range of accessories are available for use with the device including:

- Air tubing (heated and non-heated): ClimateLineAir™, SlimLine™, Standard
- Side cover for use without the humidifier
- Filter: Hypoallergenic filter, standard filter
- Air10™ DC/DC converter (12V/24V)
- SD card reader
- Air10 oximeter adapter
- Air10 USB adapter.

Note: Make sure all parts and accessories used with the device are compatible. For compatibility information, refer to www.resmed.com.

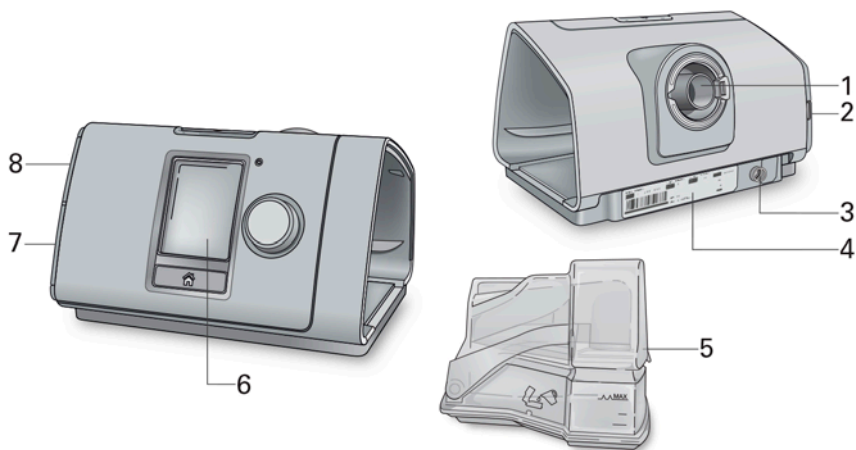

- | | | | |
|---|---------------------------------|---|---------------------|
| 1 | Air outlet | 5 | HumidAir humidifier |
| 2 | Air filter cover | 6 | Screen |
| 3 | Power inlet | 7 | Adapter cover |
| 4 | Serial number and device number | 8 | SD card cover |

About the control panel



Start/Stop button

Press to start/stop therapy.

Press and hold for three seconds to enter power save mode.



Dial

Turn to navigate the menu and press to select an option.

Turn to adjust a selected option and press to save your change.



Home button

Press to return to the Home screen.

Different icons may be displayed on the screen at different times including:



Ramp Time



Wireless signal strength (green)



Humidity



Wireless transfer not enabled (grey)



Humidifier warming



No wireless connection



Humidifier cooling



Airplane Mode

Therapy information

The following modes are available on the AirCurve 10 device:

Device	Modes available		
	VAuto	S	CPAP
AirCurve 10 VAuto	✓	✓	✓
AirCurve 10 S		✓	✓

Bilevel pressures

The AirCurve 10 device assists spontaneous breathing by cycling between two pressures in response to the patient flow or a preset fixed time.

The inspiratory positive airway pressure (IPAP, or the sum of EPAP and the pressure support level) assists inspiration.

The lower expiratory positive airway pressure (EPAP) facilitates exhalation comfort while providing a splint to maintain an open upper airway.

The difference of the two pressures—pressure support (PS) level—contributes to patient comfort.

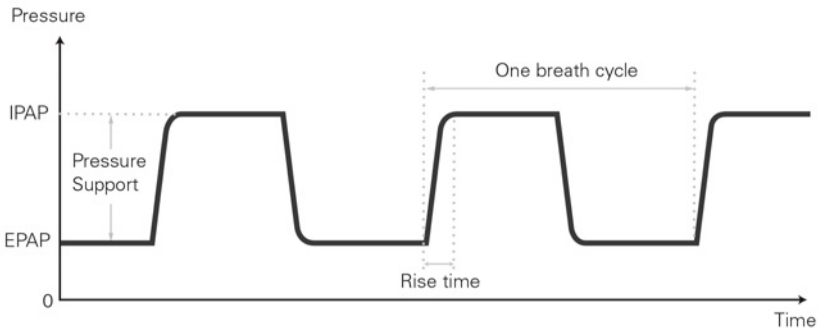

VAuto mode

In VAuto mode, the AutoSet algorithm automatically adjusts pressure in response to flow limitation, snore and obstructive apnoeas.

Min EPAP, Max IPAP and pressure support in VAuto mode

Pressure support allows you to set the difference between inspiratory and expiratory pressure and is fixed throughout the night. Min EPAP and Max IPAP settings allow you to restrict the delivered pressure ranges in which the AutoSet algorithm can operate.

The EPAP and IPAP will vary across the session according to the patient's needs. It responds to snoring, apnoeas and flow limitation of the patient's flow curve.

Min EPAP and Max IPAP can be adjusted to limit the upper and lower delivered pressure limits.

S mode

In S mode, you may set two treatment pressures—one for inspiration (IPAP) and one for expiration (EPAP). The device senses when the patient is inhaling and exhaling and supplies the pressures accordingly. The difference between IPAP and EPAP levels helps determine the tidal volume.

Triggering and cycling

VAuto and S modes only

The device has adjustable trigger/cycle sensitivity to optimise the sensing level according to patient conditions.

Under normal conditions, the device triggers (initiates IPAP) and cycles (terminates IPAP and changes to EPAP) as it senses the change in patient flow. Patient breath detection is enhanced by ResMed's VSync automatic leak management.

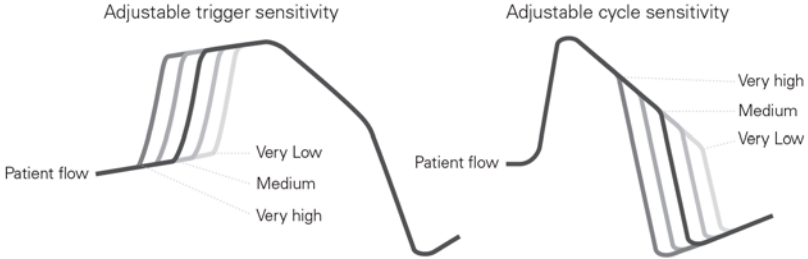

TiControl - Inspiratory time control

VAuto and S modes only

Unique to ResMed bilevel devices, TiControl™ allows the clinician to set minimum and maximum limits on the time the device spends in IPAP. The minimum and maximum time limits are set at either side of the patient's ideal spontaneous inspiratory time, providing a 'window of opportunity' for the patient to spontaneously cycle to EPAP.

The minimum time limit is set via the Ti Min parameter and the maximum time limit is set via the Ti Max parameter.

TiControl's Ti Max and Ti Min parameters play a significant role in maximising synchronisation by effectively intervening to limit or prolong the inspiratory time when required. This ensures synchronisation even in the presence of significant mouth and/or mask leak.

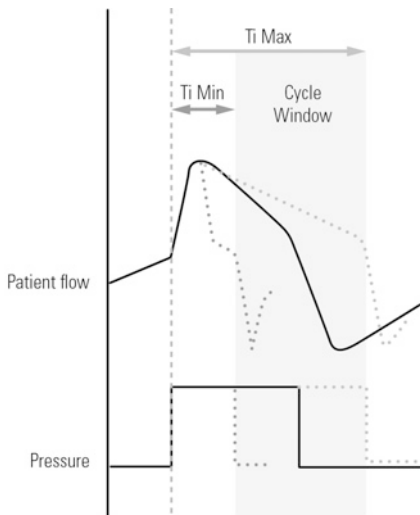

The following table is a guide to selecting the Ti Max and Ti Min values that best correspond to the patient's respiratory rate and inspiration and expiration ratio, depending on the respiratory conditions.

Examples:

- I:E = 1:1 – Ti Min prevents the premature cycling to EPAP for patients whose inspiratory effort is extremely weak.
- I:E = 1:3 – Ti Max limits the inspiration time for patients who require a longer expiration time.

Patient breath (BPM)	Ttot = 60/BPM (sec)	I:E = 1:2 (Reference)	Sufficient inhalation time		Secure exhalation time I:E = 1:3 Ti Max
			I:E = 1:1 Ti Min	Ti Max	
10	6	2	1.0	2.0	1.5
15	4	1.3	1.0	2.0	1.3
20	3	1.0	0.8	1.5	1.0
25	2.4	0.8	0.7	1.2	0.8
30	2	0.7	0.6	1.0	0.7
35	1.7	0.6	0.5	0.8	0.7
40	1.5	0.5	0.5	0.7	0.7

Rise time adjustment

S mode only

Rise Time sets the time taken for the device to reach IPAP. The greater the rise time value, the longer it takes for pressure to increase from EPAP to IPAP.

Patients with a high ventilatory demand may prefer a shorter rise time, while patients who are slow breathers may prefer a longer rise time.

Note: A prolonged rise time inhibits fast pressurisation, therefore, rise time should not be set longer than Ti Max or the patient's normal inspiratory time.

CPAP mode

In CPAP mode, a fixed pressure is delivered—with optional Expiratory Pressure Relief (EPR™).

Central sleep apnoea detection

Central sleep apnoea detection is available in VAuto, CPAP and S modes (when Easy-Breathe is enabled) on AirCurve 10 VAuto device.

The AirCurve 10 has central sleep apnoea (CSA) detection. The Summary and Detailed Data of these parameters are available to view on ResMed's patient compliance software (data availability depends on device mode and parameter measured).

The device detects both obstructive and central sleep apnoeas (CSA). CSA detection uses the Forced Oscillation Technique (FOT) to determine the state of the patient's airway during an apnoea. When an apnoea has been detected, small oscillations in pressure [1 cm H₂O (1 hPa) peak-to-peak at 4 Hz] are added to the current device pressure. The CSA detection algorithm uses the resulting flow and pressure (determined at the mask) to measure the airway patency.

Leak management with VSync

Using ResMed's VSync algorithm, the AirCurve 10 device monitors and compensates for leak by continuously and automatically adjusting the baseline flow. This enables reliable delivery of therapy pressure while maintaining patient-device synchrony.

Comfort features

Ramp

Designed to make the beginning of treatment more comfortable, ramp is available in all modes.

In VAuto and S modes, the EPAP gradually increases from the Start EPAP to the prescribed treatment pressure. Throughout Ramp, Pressure Support is maintained at the same level as that set for treatment.

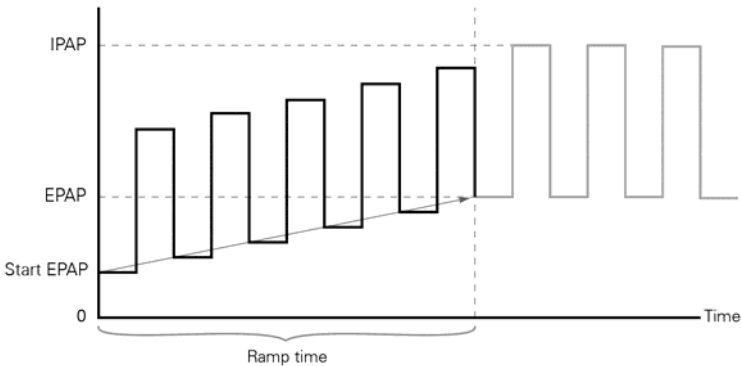

In CPAP mode, the pressure increases from a low pressure (Start Pressure) to the prescribed treatment pressure.

Expiratory Pressure Relief

The comfort feature Expiratory Pressure Relief is available in CPAP mode on the AirCurve 10 VAuto device.

Designed to make therapy more comfortable, Expiratory Pressure Relief (EPR) maintains optimal treatment for the patient during inhalation and reduces the delivered mask pressure during exhalation.

EPR On—EPR is enabled.
 Off—EPR is disabled.

The following settings are only available if EPR is On:

EPR Type Full Time—If set to Full Time, EPR is enabled for the whole therapy session.
 Ramp Only—If set to Ramp Only, EPR is only enabled during ramp time.

EPR Level 1, 2, 3 cm H₂O (1, 2, 3 hPa)

When EPR is enabled, the delivered pressure will not drop below a minimum pressure of 4 cm H₂O (4 hPa), regardless of the settings.

Easy-Breathe

The comfort feature Easy-Breathe is available in S mode on the AirCurve 10 VAuto device.

The Easy-Breathe waveform intelligently recreates a patient's individual breathing pattern, so breathing feels more natural and therapy is more comfortable.

Climate Control

Climate Control is an intelligent system that controls the humidifier and the ClimateLineAir heated air tubing to deliver constant, comfortable temperature and humidity levels during therapy.

Designed to prevent dryness of the nose and mouth, it maintains the set temperature and relative humidity during sleep. Climate Control can be set to either Auto or Manual and is only available when the ClimateLineAir and the HumidAir humidifier are attached.

Climate Control Auto

Climate Control Auto is the recommended and default setting. Climate Control Auto is designed to make therapy as easy as possible, so there is no need to change the temperature or humidity settings.

The Tube Temperature is set to Auto (27°C) and Climate Control adjusts the humidifier output to maintain a constant, comfortable humidity level of 85% relative humidity while protecting against rainout (water droplets in the air tubing and mask).

Climate Control Manual

Designed to offer more flexibility and control over settings, Climate Control Manual lets the patient adjust the temperature and humidity to the setting which is most comfortable for them.

In Climate Control Manual, the Tube Temperature and the Humidity Level can be set independently however, rainout protection is not guaranteed. If rainout does occur, first try increasing the tube temperature. If the air temperature becomes too warm and rainout continues, try decreasing the humidity.

Tube Temperature

If the air in the mask feels too warm or too cold, the patient can adjust the temperature to find what is most comfortable or turn it off completely. The Tube Temperature can be set to anywhere between 16–30°C.

The temperature sensor located at the mask end of the ClimateLineAir heated air tubing enables the system to automatically control the temperature of the air delivered to the patient. This ensures the temperature of the air delivered to the patient does not fall below the set minimum temperature, therefore maximising breathing comfort for the patient.

Humidity Level

The humidifier moistens the air and is designed to make therapy more comfortable. If the patient is getting a dry nose or mouth, turn up the humidity. If the patient is getting moisture in their mask, turn down the humidity.

The Humidity Level can be set to Off or between 1 and 8, where 1 is the lowest humidity setting and 8 is the highest humidity setting.

For each humidifier setting, the Climate Control system delivers a constant amount of water vapour, or absolute humidity (AH), to the patient's upper airway.

Automatic adjustment

The humidifier and ClimateLineAir heated air tubing are controlled by the Climate Control algorithm to deliver constant humidity and temperature outputs. The system adjusts automatically to changes in:

- ambient room temperature and humidity values
- flow due to pressure changes
- flow due to mask or mouth leak.

Setup

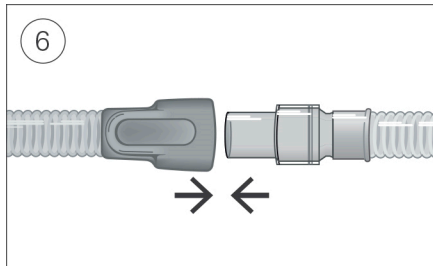
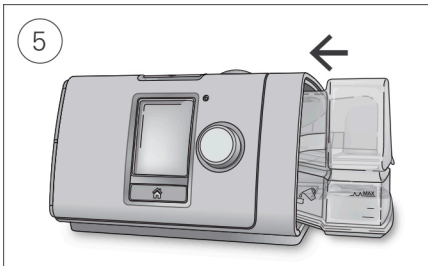
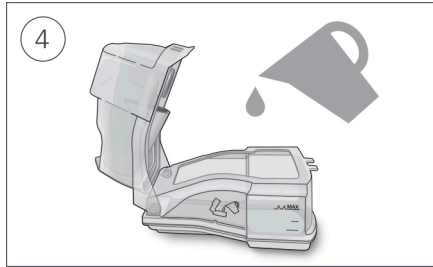
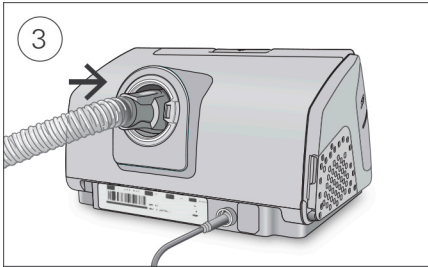
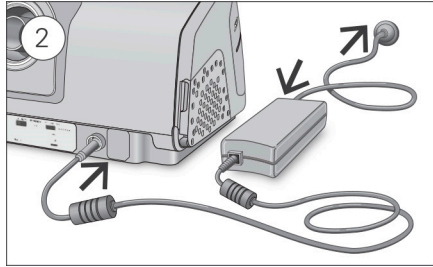
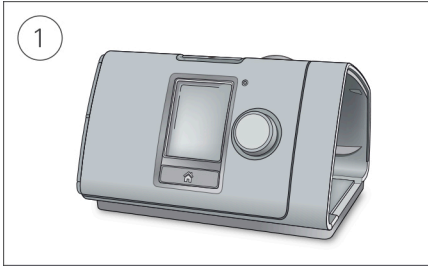

CAUTION

Do not overfill the humidifier as water may enter the device and air tubing.

1. Place the device on a stable level surface.
2. Plug the power connector into the rear of the device. Connect one end of the power cord into the power supply unit and the other end into the power outlet.
3. Connect the air tubing firmly to the air outlet located on the rear of the device.
4. Open the humidifier and fill it with water up to the maximum water level mark. Do not fill the humidifier with hot water.
5. Close the humidifier and insert it into the side of the device.
6. Connect the free end of the air tubing firmly onto the assembled mask. See the mask user guide for detailed information.

Recommended masks are available on www.resmed.com.

Supplemental oxygen

The AirCurve 10 device is designed to be compatible with up to 15 L/min of supplemental oxygen in S and CPAP modes and up to 4 L/min in VAuto mode.

At a fixed rate of supplemental oxygen flow, the inhaled oxygen concentration will vary depending on the pressure settings, patient breathing pattern, mask selection and the leak rate.

To connect supplemental oxygen to the device you need to connect an oxygen connector port. For more information on how to set up the device with supplemental oxygen, refer to the user guide supplied with that accessory.

Notes:

- Adding oxygen may affect the delivered pressure and the accuracy of the displayed leak and minute ventilation.
- Before adding oxygen, familiarise yourself and your patient with the specific warnings relating to the use of supplemental oxygen. These can be found at the end of this guide.

Antibacterial filters

Antibacterial filters increase resistance in the air circuit and may affect accuracy of displayed and delivered pressure, particularly at high flows.

ResMed recommends using an antibacterial filter with a low impedance [eg, 2 cm H₂O (2 hPa) at 60 L/min], such as PALL (BB50T), Air Safety Filter without Luer Port (4222/702) or Air Safety Filter with Side Port 24966 (4222/701). If using the Air Safety Filter with Side Port, an Oxygen Connector Port is required.

Note: When using the SlimLine air tubing above 20 cm H₂O (20 hPa), the device optimum performance may not be reached if used with an antibacterial filter. The device performance must be checked prior to prescribing the SlimLine air tubing for use with an antibacterial filter.

Accessing and exiting the Clinical Menu

You can access, view and set parameters relating to a patient's therapy and device configuration in the Clinical Menu.

To access the Clinical Menu:

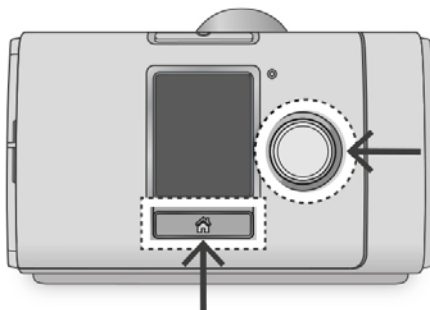

- Press and hold the dial and the Home button for three seconds.
The Home screen is displayed with an unlock icon  in the top right corner of the screen.

To exit the Clinical Menu:

- Press and hold the dial and the Home button for three seconds.
- Select **Exit Clinical Menu** from the Home screen.

The device will automatically exit the Clinical Menu after 20 minutes of inactivity.

Adjusting the clinical settings

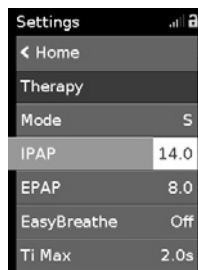
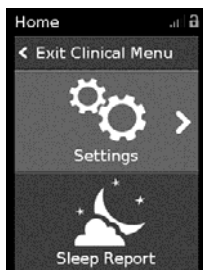

1. Access the Clinical Menu, highlight **Settings** and press the dial.
The **Settings** menu is displayed.
2. Turn the dial to highlight the setting you want to adjust and then press the dial.
3. Turn the dial to adjust the setting and press the dial to save the change.

The settings can be changed in different ways depending on the type of screen:



Turn the dial to edit live in the menu.

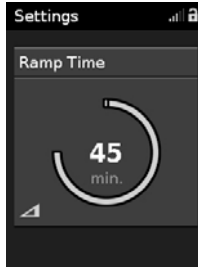

Turn the dial to change the setting.

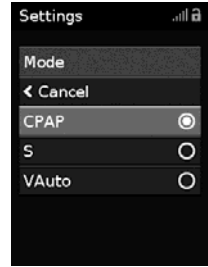

Select from a list of options.

Setting the date and time

Before you set up a new patient and start therapy for the first time, make sure you set the correct local date and time on the device. If you set the date and time after starting therapy, you may lose patient data.

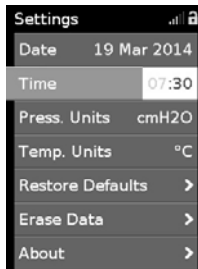

1. In **Settings** menu, select **Date** and change the setting to the correct date.
2. Select **Time** and change it to the correct local time.
3. Make sure the correct local time and date has been applied.

The AirCurve 10 settings must be configured for each individual patient. The settings should be periodically reassessed to ensure optimal therapy.

Settings menu

You set all parameters relating to a patient's therapy and device configuration in the **Settings** menu.

Note: Not all parameters are available in all regions. The default and range values may differ between modes and regions.

The range of parameters in the Settings menu are expressed in cm H₂O, where 1cm H₂O is equal to 0.98 hPa. The units can be changed under Configuration.

Therapy

Parameter	Description	VAuto	Mode S	CPAP	Range
Mode	Sets the therapy mode available on the device.	✓	✓	✓	
Set Pressure	Sets the fixed treatment pressure.			✓	4–20 cm H ₂ O (4–20 hPa), 0.2 cm H ₂ O (0.2 hPa) increments
IPAP	Set the pressure to be delivered to the patient when the device is triggered into inspiration.		✓		4–25 cm H ₂ O (4–25 hPa), 0.2 cm H ₂ O (0.2 hPa) increments
EPAP	Sets the pressure to be delivered to the patient when the device is cycled into expiration.		✓		2–25 cm H ₂ O (2–25 hPa), 0.2 cm H ₂ O (0.2 hPa) increments
Easy-Breathe	Enable / disable the Easy-Breathe feature.		✓		On / Off
Backup Rate	Set a fixed backup rate.		✓		10 BPM / Off
Ti Max	Set the maximum limit on the time the device spends in IPAP.	✓	✓		0.3–4.0 sec, 0.1 sec increments
Ti Min	Set the minimum limit on the time the device spends in IPAP.	✓	✓		0.1–[Ti Max] sec, 0.1 sec increments
Max IPAP	Sets the maximum inspiratory pressure delivered by the device.	✓			4–25 cm H ₂ O (4–25 hPa), 0.2 cm H ₂ O (0.2 hPa) increments
Min EPAP	Sets the minimum EPAP (minimum expiratory pressure) delivered by the device.	✓			4–25 cm H ₂ O (2–25 hPa), 0.2 cm H ₂ O (0.2 hPa) increments
Pressure Support (PS)	Difference between IPAP and EPAP. Adjust for patient comfort.	✓			0–10 cm H ₂ O (0–10 hPa), 0.2 cm H ₂ O (0.2 hPa) increments
Rise Time	Set the time taken for pressure to increase from EPAP to IPAP. The Rise Time scale can be approximately read as 'milliseconds' (eg, 200 is approximately 200 ms).		✓		Min / 150–900 ms, 50 ms increments

Parameter	Description	Mode			Range
		VAuto	S	CPAP	
Trigger	Set the level of inspiratory flow above which the device changes from EPAP to IPAP.	✓	✓		Very Low / Low / Med / High / Very High
Cycle	Set the level of inspiratory flow below which the device changes from IPAP to EPAP.	✓	✓		Very Low / Low / Med / High / Very High
Mask	Select the type of mask used by the patient. Refer to Mask Device Compatibility List on www.resmed.com .	✓	✓	✓	Full Face / Nasal / Pillows / Pediatric

Comfort

Parameter	Description	Mode			Range
		VAuto	S	CPAP	
Ramp Time	Set the ramp time.	✓	✓	✓	Off / 5–45 mins
Start Pressure	Set the pressure at the start of ramp, up to treatment pressure.			✓	4–Set pressure, 0.2 cm H ₂ O (0.2 hPa) increments
Start EPAP	Set the pressure at the start of ramp, up to minimum treatment pressure.	✓	✓		4–EPAP, 0.2 cm H ₂ O (0.2 hPa) increments
Climate Ctrl	Available when water tub is used and ClimateLineAir heated air tubing is connected.	✓	✓	✓	Manual / Auto
Tube Temp.	Set the minimum temperature of air delivered by heated air tubing such as ClimateLineAir.	✓	✓	✓	Off / 60–86°F (16–30°C), 1° increments
Humidity Level	Set the humidity level.	✓	✓	✓	Off / 1–8
EPR	Enable / disable EPR.			✓	On / Off
EPR Type	Available when EPR is enabled.			✓	Full Time / Ramp Only
EPR Level	Set the EPR value.			✓	1 / 2 / 3 cm H ₂ O (1 / 2 / 3 hPa)

Accessories

Parameter	Description	Range
Tube	Select the type of air tubing used by the patient. ClimateLineAir air tubing is automatically detected when connected to the device.	SlimLine / Standard / 3m
AB filter	Select Yes if you attach an antibacterial filter.	No / Yes
View oximeter	Displayed at all times when an oximeter is connected.	18-300 BPM 0-100% SpO ₂

Options

Parameter	Description	Range
Essentials	Set the level of access available to the patient.	On / Plus
Leak Alert	Enable / disable the Leak Alert feature. When enabled, leaks >40 L/min (0.7 L/s) for >20 sec result in an audible alert and a high leak message is displayed.	Off / On
SmartStart™	Enable / disable the SmartStart feature. If you enable the SmartStart feature, the device will start automatically when the patient breathes into the mask and then stop automatically when the patient removes the mask.	Off / On

Reminders

Mask	Set a recurring reminder to the patient to replace the mask.	Off / 1– 24 mths, 1 month increments
Humidifier	Set a recurring reminder to the patient to replace the humidifier.	Off / 1–24 mths, 1 month increments
Tube	Set a recurring reminder to the patient to replace the air tubing.	Off / 1–24 mths, 1 month increments
Filter	Set a recurring reminder to the patient to replace the air filter.	Off / 1–24 mths, 1 month increments

Configuration

Parameter	Description	Selection
Language	Set the display language. (Not all languages available in all regions.)	English / Français / Español / Português / Deutsch / Italiano / Nederlands / Svenska / Norsk / Dansk / Suomi / Polski / Türkçe / Русский / 简体中文 / 繁體中文
Date	Set the current date. If you set a new date that occurs in the past then an error message is displayed. Before this change can be made, erase the compliance data available under the Configuration menu.	DD Mmm YYYY

Parameter	Description	Selection
Time	Set the current time. If you set a new time that occurs in the past then an error message is displayed. Before this change can be made, erase the compliance data available under the Configuration menu.	24 hours
Press. Units	Set the unit of pressure in which pressure is displayed.	cm H ₂ O / hPa
Temp. Units	Set the temperature units.	°F / °C
Restore Defaults	Reset to default settings (except for language, date and time).	Yes / No
Erase Data	Erase all data stored on the device and the SD card. Settings, date, time and device run hours are not affected.	Yes / No
About	View Run Hours, SN, SW, provider, type, service and signal strength of the device, CX number, humidifier and internal modem.	

Starting therapy

1. Direct the patient to fit their mask.
2. Direct the patient to press Start/Stop, or if the SmartStart feature is enabled, direct them to breathe into their mask.

Therapy will begin and the **Sleep Report** screen is displayed.

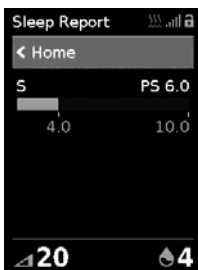

The pressure bar shows the inspiratory and expiratory pressures in green. The green bar will expand and contract as the patient breathes in and out.

The screen will go black automatically after a short period of time. You can press Home or the dial to turn it back on. If power is interrupted during therapy, the device will automatically restart therapy when power is restored.

The AirCurve 10 device has a light sensor that adjusts the screen brightness based on the light in the room.

Stopping therapy

1. Direct the patient to remove the mask.
2. Direct the patient to press Start/Stop, or if SmartStart is enabled, therapy will stop automatically after a few seconds.



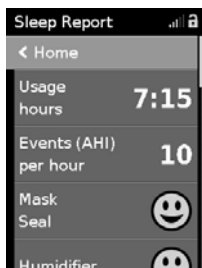

The **Sleep Report** now provides a summary of the therapy session.

Viewing the Sleep Report

The **Sleep Report** screen shows sleep quality and mask seal status for the most recent therapy session. Turn the dial to scroll down to view more detailed usage data. The parameters displayed will depend on the therapy mode.



Sleep Report screen parameters

Parameter	Description
Usage hours	Number of hours the device has been used during the last session.
Events (AHI) per hour	Apnoeas and hypopnoeas measured per hour for one day. An apnoea is when the respiratory flow decreases by more than 75% for at least 10 sec. A hypopnoea is when the respiratory flow decreases to 50% for at least 10 sec. The Apnoea Index (AI) and Apnoea-Hypopnoea Index (AHI) are calculated by dividing the total number of events that occurred by the total mask-on therapy period in hours.
Mask Seal	 Good—if the 70 th percentile leak is less than 24 L/min.  Mask needs adjustment.
Humidifier	 Humidifier attached and functional.  Humidifier fault; refer to troubleshooting section.
Total used hrs	Indicates the total number of hours the device has been used since the patient commenced therapy.
More Info	
Period	Set the time interval covered by the Sleep Report . The options are: 1 Day / 1 Week / 1 Month / 3 Months / 6 Months / 1 Year
Days Used	Number of days the device has been used during the selected period or since the last compliance data was reset.
Days 4hrs+	Number of days the device has been used for more than 4 hours during the selected period or since the last compliance data was reset.
Avg. Usage	Average number of hours per day the device has been used during the selected period.
Used Hrs	Number of hours the device has been used during the selected period or since the last compliance data reset.

Parameter	Description
Pressure	Average inspiratory pressure during the selected period (95 th percentile for each day; average of 95 th percentile values for periods >1 day).
Exp. Pressure	Average expiratory pressure during the selected period (95 th percentile for each day; average of 95 th percentile values for periods >1 day).
Leak	Average of the 95 th percentile values of leak during the selected period for days with usage only.
Vt	Average of the 50th percentile values of tidal volume during the selected period for days with usage only.
RR	Frequency of breathing, expressed as the number of breaths per minute (5-breath moving average).
MV	Average of the 50th percentile values of minute ventilation during the selected period for days with usage only.
Ti	Duration of inspiration (ie, the respiratory flow into the lungs), expressed in seconds (5-breath moving average).
I:E	I:E is the ratio of the inspiratory period to the expiratory period.
Spont Trig	Percentage of breaths that are spontaneously triggered, measured from the last 20 breaths.
Spont Cyc	Percentage of breaths that are spontaneously cycled, measured from the last 20 breaths.
AHI	Apnoea-Hypopnoea Index—average AHI during the selected period. AHI and AI are calculated for times of low leak only.
Total AI	Apnoea Index—average total AI during the selected period.
Central AI	Central Apnoea Index—average CAI of the Days Used in the selected period.

Cleaning and Maintenance

It is important that the AirCurve 10 device is cleaned regularly to ensure optimal therapy. The following sections will help with disassembling, cleaning, checking and reassembling the device.

Disassembling

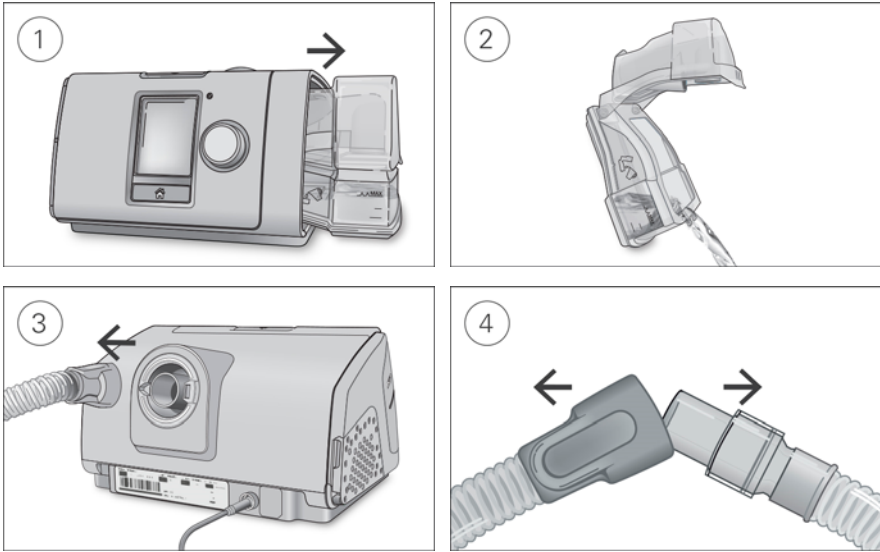

1. Hold the humidifier at the top and bottom, press it gently and pull it away from the device.
2. Open the humidifier and discard any remaining water.
3. Hold the cuff of the air tubing and gently pull it away from the device.
4. Hold both the cuff of the air tubing and the swivel of the mask, then gently pull apart.

Cleaning

You should clean the device weekly as described. Refer to the mask user guide for detailed instructions on cleaning the mask.

1. Wash the humidifier and air tubing in warm water using mild detergent.
2. Rinse the humidifier and air tubing thoroughly and allow to dry out of direct sunlight and/or heat.
3. Wipe the exterior of the device with a dry cloth.

Notes:

- The humidifier may be washed in a dishwasher on the delicate or glassware cycle (top shelf only). It should not be washed at temperatures higher than 65°C.
- Do not wash the air tubing in a dishwasher or washing machine.
- Empty the humidifier daily and wipe it thoroughly with a clean, disposable cloth. Allow to dry out of direct sunlight and/or heat.

Checking

You should regularly check the humidifier, air tubing and the air filter for any damage.

1. Check the humidifier:
 - Replace it if it is leaking or has become cracked, cloudy or pitted.
 - Replace it if the seal is cracked or torn.
 - Remove any white powder deposits using a solution of one part household vinegar to 10 parts water.
2. Check the air tubing and replace it if there are any holes, tears or cracks.
3. Check the air filter and replace it at least every six months. Replace more often if there are any holes or blockages by dirt or dust.

To replace the air filter:

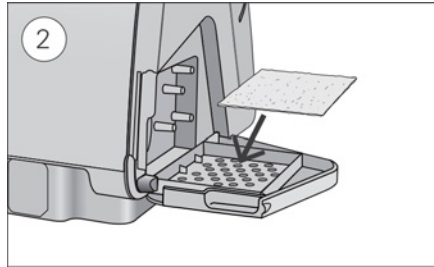
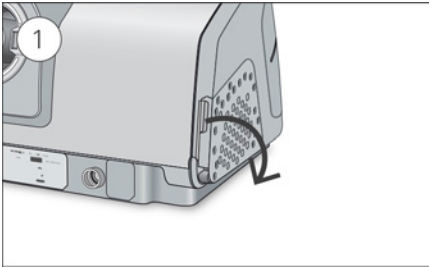

1. Open the air filter cover and remove the old air filter.
The air filter is not washable or reusable.
2. Place a new air filter onto the air filter cover and then close it.
Make sure the air filter is fitted at all times to prevent water and dust from entering the device.

Reassembling

When the humidifier and air tubing are dry, you can reassemble the parts.

1. Connect the air tubing firmly to the air outlet located on the rear of the device.
2. Open the humidifier and fill it with room temperature water up to the maximum water level mark.
3. Close the humidifier and insert it into the side of the device.
4. Connect the free end of the air tubing firmly onto the assembled mask.

Reprocessing

When the device is used for multiple patients, for example, in a sleep lab, clinic, hospital or at a health care provider, the cleanable humidifier, air outlet and air tubing should be reprocessed between each patient use.

If the cleanable humidifier or the air tubing are being used for a single user in the home, refer to the cleaning instructions in this guide or in the User Guide.

Described here are ResMed's recommended and validated procedures for cleaning and disinfecting the cleanable humidifier, air outlet and air tubing. However, the steps for disinfection vary regionally and each healthcare facility should consult its own procedures before carrying out those within this guide.

WARNING

- ResMed cannot give any assurance that deviations from the procedures listed in this guide, and their effect on the performance of the product, will be acceptable.
- When using detergents, disinfectants or sterilisation agents, always follow the manufacturer's instructions.
- Beware of electrocution. Do not immerse the device, power supply or power cord in water. If liquids are spilled into or onto the device, unplug the device and let the parts dry. Always unplug the device before cleaning and make sure that all parts are dry before plugging it back in.

Surface disinfection

1. Wipe the exterior of the device including display, externally accessible ports, side cover, power supply unit and accessories with a disposable cloth and mild detergent or alcohol disinfectant (see list below).
2. Remove any excess disinfectant with a disposable dry cloth.

Agents recommended for surface disinfection and cleaning:

- Warm water and mild detergent eg, Teepol™ multipurpose detergent
- Window cleaner or other premixed surface detergent
- Methyl alcohol solution
- 70% Ethyl alcohol solution
- 70-90% Isopropanol solution
- 10% Bleach solution
- Isopropyl wipes
- CaviCide™
- Mikrozyd®
- Actichlor™ Plus
- Terralin®.

Note: Agents may not be available in all regions.

Reprocessing the air tubing

Disconnecting

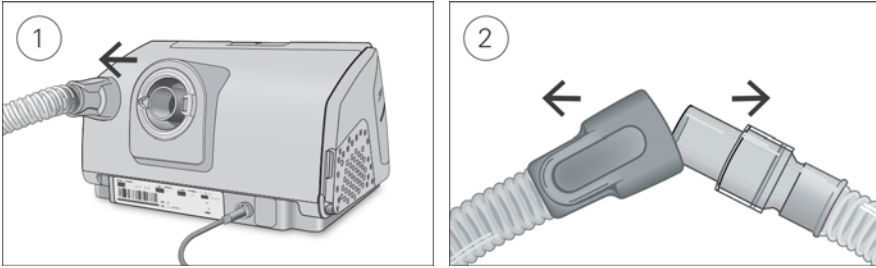

1. Hold the cuff of the air tubing and gently pull it away from the device.
2. Hold both the cuff of the air tubing and the swivel of the mask, then gently pull apart.

Decontaminating

Before the disinfection process, each component must be cleaned and rinsed so no visible contamination is present.

1. Clean all components with a soft bristled brush for one minute while soaking in detergent solution (see table below). Pay particular attention to all crevices and cavities.
2. Run the detergent solution through the air tubing repeatedly until no contamination is visible.
3. Thoroughly rinse each component according to the detergent manufacturer's instructions.

ResMed has tested the following detergents according to the manufacturer's instructions:

Detergent	Water temperature	SlimLine	ClimateLineAir	Standard
Alconox™ (diluted at 1%)	Hot water (approx 60°C) Warm water (approx 45 to 60°C) Room temperature water (approx 21°C)	✓	✓	✓
Neodisher MediZym™ (diluted at 2.0%)	Warm water (approx 45 to 60°C)	✓		✓
Gigazyme® (diluted at 1.0%)	Room temperature water (approx 21°C)		✓	

Disinfecting

In the procedures below, only one disinfection process needs to be performed.

High level thermal

Part	Validated number of cycles
	Hot water: 75°C for 30 minutes OR 70°C for 100 minutes.
SlimLine	20
ClimateLineAir	26
Standard	100

1. Immerse the air tubing in a water bath.
Take care that no air bubbles are trapped inside the air tubing.
2. Increase the water bath temperature to 70°C for 100 minutes, or a maximum of 75°C for 30 minutes. Higher temperatures may damage the tubing.
3. Air dry out of direct sunlight and/or heat.

High level chemical

Part	Validated number of cycles
	CIDEX® OPA Ortho-phthalaldehyde 0.55% for 12 minutes
	Gigasept FF® (new) 5% for 15 minutes
SlimLine	100
ClimateLineAir	26
Standard	100

1. Soak the air tubing in a commercially available solution of a chemical sterilant.
Take care that no air bubbles are trapped inside the air tubing.
2. Thoroughly rinse the air tubing in drinking quality water (five litres per assembly) by immersing it completely for a minimum of one minute in duration.
3. Repeat the rinse procedure two additional times using fresh water for a total of three rinses.
4. Air dry out of direct sunlight and/or heat.

Inspecting

Perform a visual inspection of the air tubing. If any visible deterioration is apparent (holes, tears or cracks etc), the air tubing should be discarded and replaced. Slight discoloration may occur and is acceptable.

Reconnecting the air tubing

When the air tubing is dry, you can reconnect it to the device.

1. Connect the air tubing firmly to the air outlet located on the rear of the device.
2. Connect the free end of the air tubing firmly onto the assembled mask.

Packaging and storage

Store in a dry, dust-free environment away from direct sunlight.

Storage temperature: -20°C to 60°C.

Reprocessing the humidifier and air outlet

Disassembling

The following instructions provide guidance on how to correctly disassemble the cleanable humidifier and the air outlet.

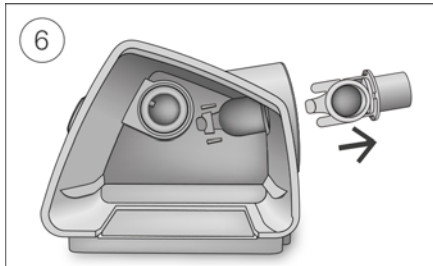
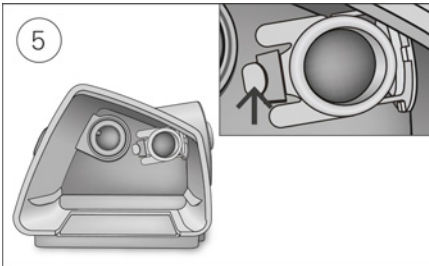
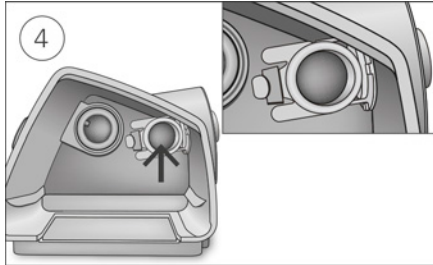
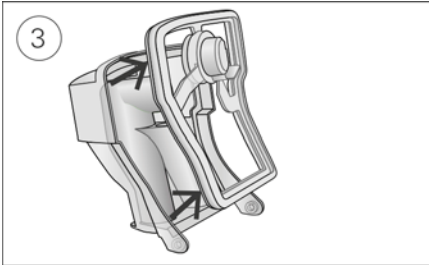
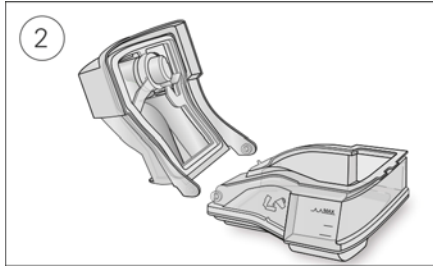
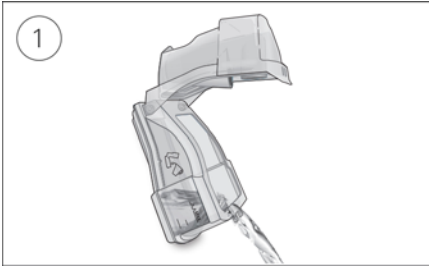

1. Remove the humidifier from the device, open it and discard any remaining water.
2. Hold the humidifier base and then fully open the humidifier lid and pull it away so that it easily detaches from the base.
3. Remove the humidifier seal from the humidifier lid by pulling it away.
4. Locate the air outlet on the inside of the device.
5. Release the air outlet by pressing the clip located inside the device.
6. Remove the air outlet by pulling it out through the air outlet socket at the rear of the device.

Decontaminating

Before the disinfection process, each component must be cleaned and rinsed so no visible contamination is present.

1. Clean all components with a soft bristled brush for one minute while soaking in detergent solution (see table below). Pay particular attention to all crevices and cavities.
2. Thoroughly rinse each component according to the detergent manufacturer's instructions.

ResMed has tested the following detergents according to the manufacturer's instructions:

Detergent	Water temperature	Cleanable humidifier	Air outlet
Alconox (diluted at 1%)	Hot water (approx or 60°C) Warm water (approx 45 to 60°C) Room temperature water (approx 21°C)	✓	✓
Gigazyme (diluted at 1.0%)	Room temperature water (approx or 21°C)	✓	✓

Disinfecting

In the procedures below, only one disinfection process needs to be performed.

High level thermal

Part	Validated number of cycles
	Hot water: 90°C for 1 minute OR 75°C for 30 minutes OR 70°C for 100 minutes. Due to specific regional requirements, ResMed cleanable humidifiers have been tested for disinfection (100 cycles) at 93°C for 10 minutes
Cleanable humidifier	130
Air outlet	130

1. Soak the disassembled components in a hot water bath at pasteurizing temperature. Take care that no air bubbles are trapped against the components.
2. Air dry out of direct sunlight and/or heat.

High level chemical

Part	Validated number of cycles
	CIDEX OPA Ortho-phthalaldehyde 0.55% for 12 minutes Gigasept FF (new) 5% for 15 minutes
Cleanable humidifier	130
Air outlet	130

1. Soak the disassembled components in a commercially available solution of a chemical sterilant. Take care that no air bubbles are trapped against the components.
2. Thoroughly rinse the cleanable humidifier in drinking quality water (five litres per assembly) by immersing it completely for a minimum of one minute in duration.
3. Repeat the rinse procedure two additional times using fresh water for a total of three rinses.
4. Air dry out of direct sunlight and/or heat.

Inspecting

Perform a visual inspection of all components. If any visible deterioration is apparent (cracking, crazing, tears, etc), the humidifier should be discarded and replaced. Slight discoloration of the silicone components may occur and is acceptable.

Reassembling

The following instructions provide guidance on how to correctly reassemble the air outlet and the humidifier.

To reassemble the air outlet

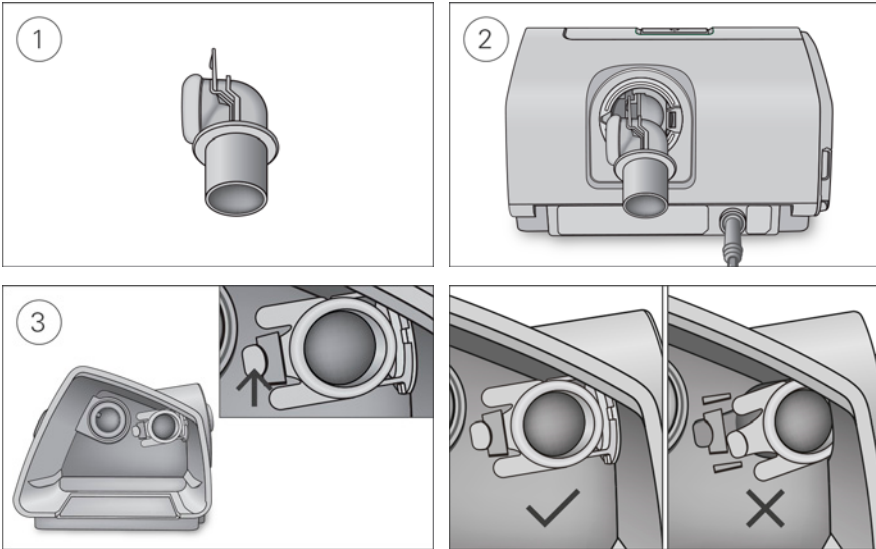

1. Hold the air outlet with the seal pointing to the left and the clip pointing forward.
2. Make sure that the air outlet is correctly aligned and insert the air outlet into the socket. It will click in place.
3. Check if the air outlet is inserted correctly as shown.

To insert the humidifier seal:

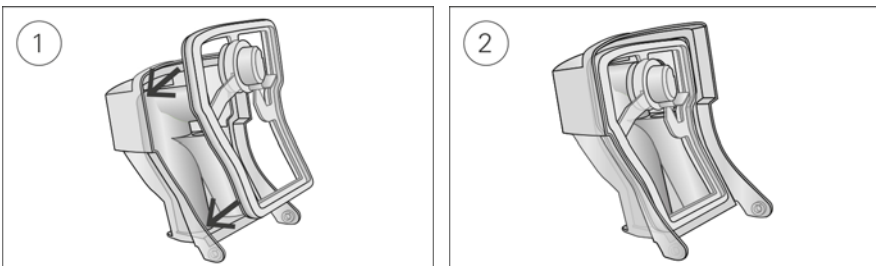

1. Place the seal into the lid.
2. Press down along all edges of the seal until it is firmly in place.

To reassemble the humidifier lid:

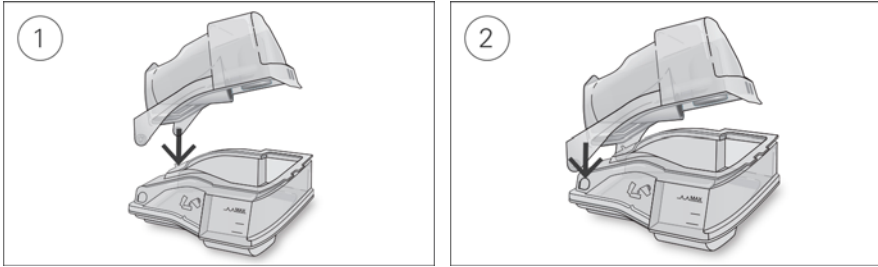

1. Insert one side of the lid into the pivot hole of the base.
2. Slide the other side down the ridge until it clicks into place.

Packaging and storage

Store in a dry, dust-free environment away from direct sunlight.

Storage temperature: -20°C to 60°C.

Data management and therapy compliance

For therapy management, the AirCurve 10 device stores patient therapy data on the device and has the ability to transfer it remotely to the care provider. Data can then be accessed via ResMed's AirView™ therapy management solution.

The AirCurve 10 device also stores data on the SD card. This data can be transferred via an SD Card Reader to ResMed's ResScan™ therapy management system.

For more information on therapy management with AirView or ResScan, refer to the manuals supplied with the software.

Remote monitoring

The AirCurve 10 device has wireless communication which has the ability to automatically transmit summary and night profile data on a regular basis. It also allows you to change settings remotely.

The Wireless signal strength icon  displayed at the top right of the screen indicates the signal strength. Advise the patient to check the signal strength on their device.

Notes:

- Therapy data might not be transmitted if used outside of the country or region of purchase.
- Devices with wireless communication might not be available in all regions.

SD card

Every AirCurve 10 device comes with an SD card already inserted and ready to be used. Once the data is loaded into ResScan or AirView via the SD Card Reader, you can review and analyse data, as well as update therapy settings and transfer them to the patient's device via the SD card.

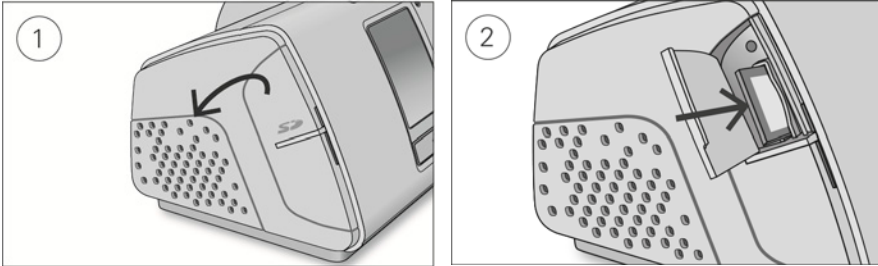

1. Open the SD card cover.
2. Push in the SD card to release it. Remove the SD card from the device.

Do not remove the SD card from the device when the SD light is flashing.

To insert the SD card:

1. Open the SD card cover.
2. Push the SD card into the device until it clicks.

The following message is briefly displayed: **Preparing SD card, do not remove power or your card.**

Data storage

The AirCurve 10 device stores summary data such as AHI, Total Hours Used and Leak. Night profile data such as snore and pulse rate are stored on the SD card and can be viewed with AirView and ResScan. High resolution flow and pressure data are stored on the SD card.

Data can be transmitted to therapy management software either remotely via wireless communication, or via SD card. The different ways of transmitting data are detailed in the table below.

For more information on therapy management with AirView or ResScan, refer to the manuals supplied with the software.

Type of data	Transmission method			Sessions stored
	Wireless communication to AirView	SD card to ResScan	SD Card to AirView (card-to-cloud)	
Summary data (compliance data)	✓	✓	✓	365
Night profile data	✓	✓	✓	Limited by usage and SD card storage capacity
High resolution flow and pressure data (25 Hz - every 40 ms)		✓		

Night profile data are stored on the SD card and can be viewed via ResScan or AirView. Examples of night profile data available are shown below.

Night profile data

Parameter	Sampling rate	
	ResScan	AirView
Apnoea or hypopnoea events	aperiodic	aperiodic
Flow limitation (flat to round)	1/2 Hz (2 sec)	1 min
Leak (L/sec)	1/2 Hz (2 sec)	1 min
Minute ventilation (L/min)	1/2 Hz (2 sec)	1 min
Pressure (cm H ₂ O / hPa)	1/2 Hz (2 sec)	1 min
Snore (quiet to loud)	1/2 Hz (2 sec)	1 min
Pulse rate (beats/min)—if an oximeter adapter is attached	1 Hz (1 sec)	1 min
Oxygen saturation (SpO ₂)—if an oximeter adapter is attached	1 Hz (1 sec)	1 min

Software upgrade

The device has a software upgrade feature. When a software upgrade is in progress, the screen will flash for approximately 10 minutes.

Managing patient care

The following section has been provided to assist you with managing your patients' care.

Patient menu

In the patient menu there are two types of access levels, Essentials and Essentials Plus.

Essentials is designed to make the device interaction and menu navigation easier for patients. It is a simple choice for patients who do not want to worry about settings or menu navigation. It provides access to the most important comfort features such as Ramp Time, Humidity Level (if humidifier available) and Run Mask Fit.

However, by enabling Essentials Plus you can allow highly engaged patients to access additional features for control over more of their therapy settings, including changing their mask type, EPR (if available), SmartStart and Run Warmup (if humidifier available).

Essentials Plus can be enabled via the Settings menu. For more information on the patient menu, see the User Guide.

Therapy data

The device has the ability to transmit a patient's compliance data remotely via wireless communication.

If you wish to use wireless communication, advise patients to check the Wireless signal strength icon  once they have the device set up at home. The icon will indicate the strength of coverage by the number of bars displayed—the higher the number of bars, the stronger the signal.

Travelling

Patients can take their AirCurve 10 device wherever they go. Advise patients of the following:

- Use the travel bag provided to prevent damage to the device.
- Empty the humidifier and pack it separately in the travel bag.
- Make sure the patient has the appropriate power cord for the region of travel. For information on purchasing, contact your ResMed representative.
- When using an external battery, turn off the humidifier in order to maximise battery life. Do this by turning the **Humidity Level** to Off.

Travelling by plane

The AirCurve 10 device may be taken on board as carry-on luggage. Medical devices do not count toward the carry-on luggage limit.

The AirCurve 10 device can be used on a plane as it meets the Federal Aviation Administration (FAA) requirements. Air travel compliance letters can be downloaded and printed from www.resmed.com.

When using the device on a plane:

- Make sure the humidifier is completely empty and inserted into the device. The device will not work without the humidifier inserted.
- Turn on **Airplane Mode** (for instructions refer to the User Guide).

CAUTION



Do not use the device with water in the humidifier on a plane due to the risk of inhalation of water during turbulence.

Troubleshooting

If there is a problem, try the following suggestions. If you are not able to fix the problem, contact your local ResMed dealer or ResMed office. Do not open the device.



General troubleshooting

Problem/possible cause	Solution
Air is leaking from around the mask Mask may be fitted incorrectly.	Make sure the mask is fitted correctly. See mask user guide for fitting instructions or use the Mask Fit function to check mask fit and seal.
The patient is getting a dry or blocked nose Humidity level may be set too low.	Adjust the Humidity Level. If you have ClimateLineAir heated air tubing, see the ClimateLineAir user guide.
There are droplets of water in the mask and air tubing Humidity level may be set too high.	Adjust the Humidity Level. If you have ClimateLineAir heated air tubing, see the ClimateLineAir user guide.

Problem/possible cause	Solution
The patient is getting a very dry mouth	
Air may be escaping through the patient's mouth.	Increase the Humidity Level. The patient may need a chin strap to keep the mouth closed or a full face mask.
The patient feels that too much air is being delivered from the device	
Ramp may be turned off.	Use the Ramp Time option.
The patient feels that not enough air is being delivered from the device	
Ramp may be in progress.	Wait for air pressure to build up or turn Ramp Time off.
Ramp start pressure may be too low.	Increase Ramp start pressure.
No display	
Backlight on the screen may have turned off. It turns off automatically after a short period of time.	Press Home or the dial to turn it back on.
Power may not be connected.	Connect the power supply and make sure the plug is fully inserted.
Therapy has stopped, but the device is still blowing air	
Device is cooling down.	Device blows a small amount of air in order to avoid condensation in the air tubing. It will stop automatically after 20 minutes.
Humidifier is leaking	
Humidifier may not be assembled correctly.	Check for damage and reassemble the humidifier correctly.
Humidifier may be damaged or cracked.	Replace the humidifier.
The patient's therapy data has not been transmitted	
Wireless coverage may be poor.	Advise the patient to place the device where there is coverage (ie, on their bedside table, not in a drawer or on the floor). The Wireless signal strength icon  indicates good coverage when all bars are displayed, and poor coverage when fewer bars are displayed.
The No wireless connection icon  is displayed on the top right of the screen. No wireless network available.	Advise the patient that therapy data can be sent using the SD Card.
Device may be in Airplane Mode.	Turn off Airplane Mode, see Travelling by plane.
SmartStart is enabled, but the device does not automatically start when the patient breathes into their mask	
Breath is not deep enough to trigger SmartStart.	To start therapy, take a deep breath in and out through the mask, before breathing normally. Press Start.

Problem/possible cause	Solution
There is excessive leak.	Adjust the mask and headgear. Air tubing may not be connected properly. Connect firmly at both ends.
SmartStart is enabled, but the device does not automatically stop when the patient removes their mask	
Incompatible mask being used.	Only use equipment recommended by ResMed. Contact ResMed or see www.resmed.com for more information. If the patient is using a nasal pillows mask with set pressure less than 7 cm H ₂ O (7 hPa), SmartStart will not work and should be disabled.
A pediatric mask with a set pressure less than 8 cm H ₂ O (8 hPa) is used.	Disable SmartStart.

Device messages

Device message/possible cause	Solution
High leak detected, check your water tub, tub seal or side cover	
Humidifier may not be inserted properly.	Make sure the humidifier is correctly inserted.
Humidifier seal may not be inserted properly.	Open the humidifier and make sure that the seal is correctly inserted.
High leak detected, connect your tubing	
Air tubing may not be connected properly.	Make sure the air tubing is firmly connected at both ends.
Mask may be fitted incorrectly.	Make sure the mask is fitted correctly. See mask user guide for fitting instructions or use the Mask Fit function to check mask fit and seal.
Tubing blocked, check your tubing	
Air tubing may be blocked.	Check the air tubing and remove any blockages. Press the dial to clear the message and then press Start/Stop to restart the device.
Read only card, please remove, unlock and re-insert SD card	
SD card switch may be in the lock (read-only) position.	Move the switch on the SD Card from the lock position  to the unlock position  and then re-insert it.
Date and time can not be set in the past	
Date and time were not set before data was recorded.	Select Erase Data in Settings . Once the data is erased, set the correct local date and time.
System fault, refer to user guide, Error 004	
Device may have been left in a hot environment.	Allow to cool before re-use. Disconnect the power supply and then reconnect it to restart the device.

Device message/possible cause	Solution
Air filter may be blocked.	Check the air filter and replace it if there are any blockages. Disconnect the power supply and then reconnect it to restart the device.
Air tubing may be blocked.	Check the air tubing and remove any blockages. Press the dial to clear the message and then press Start/Stop to restart the device.
There may be water in the air tubing.	Empty the water from the air tubing. Disconnect the power supply and then reconnect it to restart the device.
All other error messages, for example, System fault, refer to user guide, Error OXX	
An unrecoverable error has occurred on the device.	Contact your local ResMed dealer or ResMed office. Do not open the device.

General warnings and cautions

WARNING

- Make sure that you arrange the air tubing so that it will not twist around the head or neck.
- Make sure the power cord and plug are in good condition and the equipment is not damaged.
- Keep the power cord away from hot surfaces.
- If you notice any unexplained changes in the performance of the device, if it is making unusual sounds, if the device or the power supply are dropped or mishandled, or if the enclosure is broken, discontinue use and contact your care provider or your ResMed Service Centre.
- Do not open or modify the device. There are no user serviceable parts inside. Repairs and servicing should only be performed by an authorised ResMed service agent.
- Beware of electrocution. Do not immerse the device, power supply or power cord in water. If liquids are spilled into or onto the device, unplug the device and let the parts dry. Always unplug the device before cleaning and make sure that all parts are dry before plugging it back in.
- Supplemental oxygen must not be used while smoking or in the presence of an open flame.
- Always make sure that the device is turned on and airflow generated before the oxygen supply is turned on. Always turn the oxygen supply off before the device is turned off, so that unused oxygen does not accumulate within the device enclosure and create a risk of fire.
- Do not perform any maintenance tasks while the device is in operation.
- The device should not be used adjacent to or stacked with other equipment. If adjacent or stacked use is necessary, the device should be observed to verify normal operation in the configuration in which it will be used.
- The use of accessories other than those specified for the device is not recommended. They may result in increased emissions or decreased immunity of the device.

CAUTION

- Use only ResMed parts and accessories with the device. Non-ResMed parts may reduce the effectiveness of the treatment and/or damage the device.
- Use only vented masks recommended by ResMed or by the prescribing doctor with this device. Fitting the mask without the device blowing air can result in rebreathing of exhaled air. Make sure that the mask vent holes are kept clear and unblocked to maintain the flow of the fresh air into the mask.
- Be careful not to place the device where it can be bumped or where someone is likely to trip over the power cord.
- Blocking the air tubing and/or air inlet of the device while in operation could lead to overheating of the device.
- Keep the area around the device dry, clean and clear of anything (eg, clothes or bedding) that could block the air inlet or cover the power supply unit.
- Do not place the device on its side as water might get into the device.
- Incorrect system setup may result in incorrect mask pressure reading. Ensure the system is correctly set up.
- Do not use bleach, chlorine, alcohol, or aromatic-based solutions, moisturising or antibacterial soaps or scented oils to clean the device, the humidifier or air tubing. These solutions may cause damage or affect the humidifier performance and reduce the life of the products.
- If you use the humidifier, always place the device on a level surface lower than the patient's head to prevent the mask and air tubing from filling with water.
- Do not overfill the humidifier as water may enter the device and air tubing.
- Leave the humidifier to cool for ten minutes before handling to allow the water to cool and to make sure that the humidifier is not too hot to touch.
- Make sure that the humidifier is empty before transporting the device.

Technical specifications

Units are expressed in cm H₂O and hPa. 1 cm H₂O is equal to 0.98 hPa.

90W power supply unit

AC input range:	100–240V, 50–60Hz 1.0–1.5A, Class II 115V, 400Hz 1.5A, Class II (nominal for aircraft use)
DC output:	24V  3.75A
Typical power consumption:	53W (57VA)
Peak power consumption:	104W (108VA)

Environmental conditions

Operating temperature:	+5°C to +35°C Note: The air flow for breathing produced by this therapy device can be higher than the temperature of the room. Under extreme ambient temperature conditions (40°C) the device remains safe.
Operating humidity:	10 to 95% relative humidity, non-condensing
Operating altitude:	Sea level to 2,591 m; air pressure range 1013 hPa to 738 hPa
Storage and transport temperature:	-20°C to +60°C
Storage and transport humidity:	5 to 95% relative humidity, non-condensing

Electromagnetic compatibility

The AirCurve 10 complies with all applicable electromagnetic compatibility requirements (EMC) according to IEC60601-1-2:2007, for residential, commercial and light industry environments. It is recommended that mobile communication devices are kept at least 1 m away from the device.

Information regarding the electromagnetic emissions and immunity of this ResMed device can be found on www.resmed.com, on the Products page under Service and Support.

EN 60601-1:2006 classification

Class II (double insulation), Type BF, Ingress protection IP22.

Sensors

Pressure sensor:	Internally located at device outlet, analogue gauge pressure type, -5 to +45 cm H ₂ O (-5 to +45 hPa)
Flow sensor:	Internally located at device inlet, digital mass flow type, -70 to +180 L/min

Maximum single fault steady pressure

Device will shut down in the presence of a single fault if the steady state pressure exceeds:
30 cm H₂O (30 hPa) for more than 6 sec or 40 cm H₂O (40 hPa) for more than 1 sec.

Sound

Pressure level measured according to EN ISO 17510-1:2009 (CPAP mode):

SlimLine:	26.6 dBA with uncertainty of 2 dBA
Standard:	26.6 dBA with uncertainty of 2 dBA

Power level measured according to EN ISO 17510-1:2009 (CPAP mode):

SlimLine:	34.6 dBA with uncertainty of 2 dBA
Standard:	34.6 dBA with uncertainty of 2 dBA

Declared dual-number noise emission values in accordance with ISO 4871:1996.

Physical - device and humidifier

Dimensions (H x W x D):	116 mm x 255 mm x 150 mm
Air outlet (complies with ISO 5356-1:2004):	22 mm
Weight (device and cleanable humidifier):	1248 g
Housing construction:	Flame retardant engineering thermoplastic
Water capacity:	To maximum fill line 380 mL
Cleanable humidifier - material:	Injection moulded plastic, stainless steel and silicone seal

Temperature

Maximum heater plate:	68°C
Cut-out:	74°C
Maximum gas temperature:	≤ 41°C

Air filter

Standard:	Material: Polyester non woven fibre Average arrestance: >75% for ~7 micron dust
Hypoallergenic:	Material: Acrylic and polypropylene fibres in a polypropylene carrier Efficiency: >98% for ~7-8 micron dust; >80% for ~0.5 micron dust

Aircraft use

ResMed confirms that device meets the Federal Aviation Administration (FAA) requirements (RTCA/DO-160, section 21, category M) for all phases of air travel.

Wireless module

Technology used: 2G GSM

It is recommended that the device is a minimum distance of 2 cm from the body during operation. Not applicable to masks, tubes or accessories

Declaration of Conformity (DoC to the R&TTE Directive)

ResMed declares that the AirCurve 10 device is in compliance with the essential requirements and other relevant provisions of Directive 1999/5/EC. A copy of the declaration of conformity (DoC) can be found on www.ResMed.com/ProductSupport.

Operating pressure range

S, VAuto: 2 to 25 cm H₂O (2 to 25 hPa)
CPAP: 4 to 20 cm H₂O (4 to 20 hPa)

Supplemental oxygen

Maximum flow: 15 L/min (CPAP, S); 4 L/min (VAuto)

Pneumatic flow path

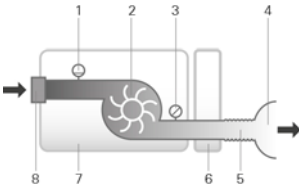

1. Flow sensor
2. Blower
3. Pressure sensor
4. Mask
5. Air tubing
6. Humidifier
7. Device
8. Inlet filter

Design life

Device, power supply unit: 5 years
Cleanable humidifier: 2.5 years
Air tubing: 6 months

Humidifier performance

The following settings have been tested at 22°C ambient temperature:

Mask Pressure cm H ₂ O (hPa)	RH output %		Nominal system output AH ¹ , BTPS ²	
	Setting 4	Setting 8	Setting 4	Setting 8
3	85	100	6	>10
4	85	100	6	>10
10	85	100	6	>10
20	85	90	6	>10
25	85	90	6	>10

¹ AH - Absolute Humidity in mg/L

² BTPS - Body Temperature Pressure Saturated

Air tubing

Air tubing	Material	Length	Inner diameter
ClimateLineAir	Flexible plastic and electrical components	2 m	15 mm
SlimLine	Flexible plastic	1.8 m	15 mm
Standard	Flexible plastic	2 m	19 mm

Heated air tubing temperature cut-out: ≤ 41°C

Notes:

- The manufacturer reserves the right to change these specifications without notice.
- The electrical connector end of the heated air tubing is only compatible with the air outlet at the device end and should not be fitted to the mask.
- Do not use electrically conductive or antistatic air tubing.
- The temperature and relative humidity settings displayed are not measured values.

Displayed values

Value	Range	Display resolution
Pressure sensor at air outlet:		
Mask pressure	2–25 cm H ₂ O (2–25 hPa)	0.1 cm H ₂ O
Flow derived values:		
Leak	0–120 L/min	1 L/min
Tidal volume	0–4000 mL	1 mL
Respiratory rate	0–50 BPM	1 BPM
Minute ventilation	0–30 L/min	0.1 L/min
Ti	0.1–4.0 sec	0.1 sec
I:E ratio	1:100 – 2:1	0.1
Value	Accuracy ¹	
Pressure measurement ¹ :		
Mask pressure ²	±[0.5 cm H ₂ O (0.5 hPa) + 4% of measured value]	
Flow and flow derived values ¹ :		
Flow	±6 L/min or 10% of reading, whichever is greater, at 0 to 150 L/min positive flow	
Leak ²	±12 L/min or 20% of reading, whichever is greater, 0 to 60 L/min	
Tidal volume ^{2,3}	±20%	
Respiratory rate ^{2,3}	±1.0 BPM	
Minute ventilation ^{2,3}	±20%	

¹ Results are expressed at ATPD (Ambient Temperature and Pressure, Dry).

² Accuracy may be reduced by the presence of leaks, supplemental oxygen, tidal volumes <100 mL or minute ventilation <3 L/min.

³ Measurement accuracy verified as per EN ISO 10651-6:2009 for Home Care Ventilatory Support Devices (Figure 101 and Table 101) using nominal ResMed mask vent flows.

Pressure accuracy

Maximum static pressure variation at 10 cm H₂O (10 hPa) according to EN ISO 17510-1:2009

	Standard air tubing	SlimLine air tubing
Without humidification	± 0.5 cm H ₂ O (± 0.5 hPa)	± 0.5 cm H ₂ O (± 0.5 hPa)
With humidification	± 0.5 cm H ₂ O (± 0.5 hPa)	± 0.5 cm H ₂ O (± 0.5 hPa)

Maximum dynamic pressure variation according to EN ISO 17510-1:2009

Device without humidification and Standard air tubing / Device with humidification and Standard air tubing			
Pressure [cm H ₂ O (hPa)]	10 BPM	15 BPM	20 BPM
4	0.5 / 0.5	0.5 / 0.5	0.8 / 0.8
8	0.5 / 0.5	0.5 / 0.5	0.8 / 0.8
12	0.5 / 0.5	0.5 / 0.5	0.8 / 0.8
16	0.5 / 0.5	0.5 / 0.5	0.8 / 0.8
20	0.5 / 0.5	0.5 / 0.5	0.8 / 0.8
25	0.3 / 0.3	0.5 / 0.4	0.7 / 0.7
Device without humidification and SlimLine air tubing / Device with humidification and SlimLine air tubing			
Pressure [cm H ₂ O (hPa)]	10 BPM	15 BPM	20 BPM
4	0.5 / 0.5	0.5 / 0.5	0.8 / 0.8
8	0.5 / 0.5	0.5 / 0.5	0.8 / 0.8
12	0.5 / 0.5	0.5 / 0.5	0.8 / 0.8
16	0.5 / 0.5	0.5 / 0.5	0.8 / 0.8
20	0.5 / 0.5	0.5 / 0.5	0.8 / 0.8
25	0.4 / 0.3	0.6 / 0.5	0.8 / 0.8

























Flow (maximum) at set pressures

The following are measured accordingly to EN ISO 17510-1:2009 at the end of the specified air tubing:

Pressure cm H ₂ O (hPa)	AirCurve 10 and Standard L/min	AirCurve 10, humidification and Standard L/min	AirCurve 10 and SlimLine L/min	AirCurve 10, humidification and ClimateLineAir L/min
4	180	143	162	151
8	168	135	151	142
12	157	136	140	135
16	144	134	128	121
20	131	123	117	109
25	120	115	96	84

Symbols

The following symbols may appear on the product or packaging.

 Read instructions before use.
  Indicates a warning or caution.
  Follow instructions before use.
  Manufacturer.
  European Authorised Representative.
  Batch code.
  Catalogue number.
  Serial number.
  Device number.
  On / Off.
  Device weight.
 IP22 Protected against finger sized objects and against dripping water when tilted up to 15 degrees from specified orientation.
  Direct current.
  Type BF applied part.
  Class II equipment.
  Humidity limitation.
  Temperature limitation.
  Non-ionising radiation.
  China pollution control logo 1.
  China pollution control logo 2.
 Rx Only Prescription only (In the US, Federal law restricts these devices to sale by or on the order of a physician).
  Maximum water level.
  Use distilled water only.
  Operating altitude.
  Atmospheric pressure limitation.
  Complies with RTCA DO-160 section 21, category M.



Environmental information

This device should be disposed of separately, not as unsorted municipal waste. To dispose of your device, you should use appropriate collection, reuse and recycling systems available in your region. The use of these collection, reuse and recycling systems is designed to reduce pressure on natural resources and prevent hazardous substances from damaging the environment.

If you need information on these disposal systems, please contact your local waste administration. The crossed-bin symbol invites you to use these disposal systems. If you require information on collection and disposal of your ResMed device please contact your ResMed office, local distributor or go to www.resmed.com/environment.

Servicing

The AirCurve 10 device is intended to provide safe and reliable operation when operated in accordance with the instructions provided by ResMed. ResMed recommends that the AirCurve 10 device be inspected and serviced by an authorised ResMed Service Centre if there is any sign of wear or concern with device function. Otherwise, service and inspection of the products generally should not be required during their design life.

Limited warranty

ResMed Ltd (hereafter 'ResMed') warrants that your ResMed product shall be free from defects in material and workmanship from the date of purchase for the period specified below.

Product	Warranty period
<ul style="list-style-type: none">• Mask systems (including mask frame, cushion, headgear and tubing)—excluding single-use devices• Accessories—excluding single-use devices• Flex-type finger pulse sensors• Humidifier water tubs	90 days
<ul style="list-style-type: none">• Batteries for use in ResMed internal and external battery systems	6 months
<ul style="list-style-type: none">• Clip-type finger pulse sensors• CPAP and bilevel device data modules• Oximeters and CPAP and bilevel device oximeter adapters• Humidifiers and humidifier cleanable water tubs• Titration control devices	1 year
<ul style="list-style-type: none">• CPAP, bilevel and ventilation devices (including external power supply units)• Battery accessories• Portable diagnostic/screening devices	2 years

This warranty is only available to the initial consumer. It is not transferable.

If the product fails under conditions of normal use, ResMed will repair or replace, at its option, the defective product or any of its components.

This Limited Warranty does not cover: a) any damage caused as a result of improper use, abuse, modification or alteration of the product; b) repairs carried out by any service organisation that has not been expressly authorised by ResMed to perform such repairs; c) any damage or contamination due to cigarette, pipe, cigar or other smoke; and d) any damage caused by water being spilled on or into an electronic device.

Warranty is void on product sold, or resold, outside the region of original purchase.

Warranty claims on defective product must be made by the initial consumer at the point of purchase.

This warranty replaces all other expressed or implied warranties, including any implied warranty of merchantability or fitness for a particular purpose. Some regions or states do not allow limitations on how long an implied warranty lasts, so the above limitation may not apply to you.

ResMed shall not be responsible for any incidental or consequential damages claimed to have resulted from the sale, installation or use of any ResMed product. Some regions or states do not allow the exclusion or limitation of incidental or consequential damages, so the above limitation may not apply to you.

This warranty gives you specific legal rights, and you may also have other rights which vary from region to region. For further information on your warranty rights, contact your local ResMed dealer or ResMed office.



ResMed Ltd

1 Elizabeth Macarthur Drive
Bella Vista NSW 2153 Australia

DISTRIBUTED BY

ResMed Corp 9001 Spectrum Center Boulevard San Diego CA 92123 USA
EC REP ResMed (UK) Ltd 96 Jubilee Ave Milton Park Abingdon Oxfordshire OX14 4RW UK

See www.resmed.com for other ResMed locations worldwide. For patent and other intellectual property information, see www.resmed.com/ip. Air10, AirCurve, AirView, ClimateLine, HumidAir, PaceWave, ResScan, SlimLine and SmartStart are trademarks of ResMed Ltd. AutoSet, ClimateLine, ResScan, SlimLine and SmartStart are registered in U.S. Patent and Trademark Office. Actichlor is a trademark of Ecolab US Inc. Alconox is a trademark of Alconox Inc. Cavicide is a registered trademark of Metrex Research, LLC. CIDEX is a registered trademark of Advanced Sterilization Products, Division of Ethicon US, LLC. Mikrozyd and Terralin are trademarks of Schülke & Mayr GmbH. Neodisher MediZym is a trademark of Chemische Fabrik Dr Weigert GmbH & Co. KG. SD Logo is a trademark of SD-3C, LLC. Teepol is a trademark of Shell Chemical Co. © 2014 ResMed Ltd. 378268/1 2014-11



0123

ResMed.com